

COMÉRCIO DE ARTIGOS ELÉTRICOS. LDA  
 Rua da MATRIZ. 6 - Tel/Fax (058)941403  
 4990 PONTE DE LIMA

"SERVICE INFORMATION IS FOR USE BY QUALIFIED PERSONNEL ONLY –  
 ANY MISADJUSTMENT OR MISALIGNMENT MAY BE TREATED AS A NON-WARRANTY  
 REPAIR BY ANY MARANTZ SERVICE CENTRE –"

**Kind of Common Parts**

**RESISTOR**

- R\*\*\*** (1) GD05 --- 140, Carbon film fixed resistor, ±5% 1/4W
- R\*\*\*** (2) GD05 --- 160, Carbon film fixed resistor, ±5% 1/6W

**C\*\*\* : CERAMIC CAP.**

- (1) DD1 ---- 370, Ceramic condenser, disc type (titan condenser)  
Temp. coeff. P350 ~ N1000 50V

**C\*\*\* : CERAMIC CAP.**

- (1) DK16 --- 300, High dielectric constant ceramic condenser, disc type (titan variable)  
Temp. chara. 2B4 50V

**C\*\*\* : ELECTROLY CAP. (⚡) / FILM CAP. (≡)**

- (1) EA ----- 10, Electrolytic condenser, one-way lead type, tolerance ±20%
- (2) DF15 --- 350, Plastic film condenser, one-way type, Mylar, ±5% 50V

\* In case of ordering the common parts, please establish the correct parts number of 10 figures by the procedure "ASSIGNMENT OF COMMON PARTS CODES"

GND

P100

TOP VIEW

TOP VIEW

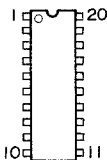
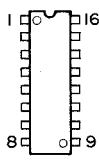
LA1245  
LM7000LA1231N  
AN7470

FRONT VIEW

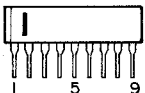

AN6875

TOP VIEW

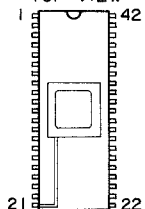

LC6502D - 726

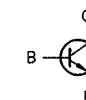
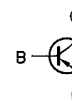
QA01, QA05  
HF200551D0  
2SK55DQA03  
HC10058030  
LA1245QA04  
HT406551E0  
2SD655EQA07, QA08, Q203 ~ Q205  
Q303 ~ Q305, Q504, Q505  
Q803, Q804  
HT30001000  
2SC536 SP (F, G) or  
2SC2785 (F, E) etcQA09, QA10, Q206, Q302  
Q502  
HT10001000  
2SA608SP (F, G) or  
2SA1175 (F, E) etcQR01  
HC10163030  
LC6502D - 726QX01  
HC10065020  
AN6875Q201  
HT308291C0  
2SC829CQ202  
HC10028030  
LA1231NQ301  
HC10046020  
AN7470Q501  
HC10164030  
LM7000Q801  
HC10077030  
L78M15Q802  
HT408631B0  
2SD863EQA02, QA06, Q503  
HF200300B0  
2SK30Y1DA01, DA03, DA04, DA06  
HD40006030  
SVC321SPDA02, DA05, DA07, DA08  
DA09, DR01 ~ DR07  
DR10 ~ DR12, D807 ~ D809  
HD20015210  
ISS133DX01 ~ DX04  
Hi10047320  
GL - 3NG5DX05  
Hi10012320  
GL - 3HD5D801 ~ D805  
HD20016210  
ISR35 - 200AD806  
HD30015020  
MA1240M

2SA608SP (F, G)

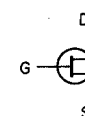
2SC829C  
2SD655E  
2SC536 SP (F, G)

2SK55D

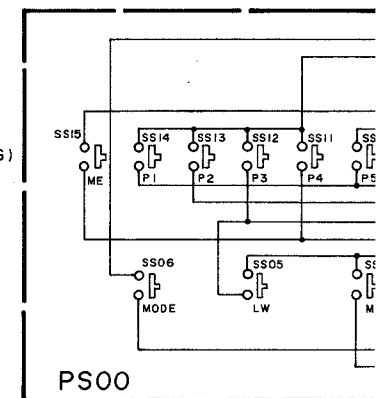

COMÉRCIO DE ARTIGOS ELÉTRICOS. LDA  
Rua da MATRIZ, 6 - Tel/Fax (058)941403  
4990 PONTE DE LIMA

J092 YP04000580 PLUG A.C. INLET  
L051 LA00035010 ANT. COIL  
W001 ZC01805010 A.C. POWER CORD  
A101 AV01202130 V.H.F. TUNER  
CA11 CT12000090 TRIMMING 20PF  
FA01 FF10045320 CERAMIC FILTER SFZ450F3L  
F201 FF11070620 CERAMIC FILTER SFE10.7MS3-A  
F202 FF11070620 CERAMIC FILTER SFE10.7MS3-A  
JC01 YT01050040 TERMINAL ANT.  
JC02 YT02020380 TERMINAL OUTPUT  
LA01 LA10295140 ANT. COIL (MW)  
LA02 LO10013170 OSC COIL (MW)  
LA03 LA10295150 ANT. COIL (LW)  
LA04 LO10013180 OSC COIL (LW)  
LA05 LI10013210 I.F.T. (AM)

L201 LI20029040 I.F.T. (FM)  
L202 LS10295030 M.P.X. COIL  
L801 TS14142010 POWER TRANSF.  
RA24 RA02230600 TRIMMING 22KΩ  
R215 RA04730600 TRIMMING 47KΩ  
R303 RA04720600 TRIMMING 4.7KΩ  
R317 RA02240600 TRIMMING 220KΩ  
SS01  
{ SP01010970 PUSH SWITCH  
SS15  
X501 XB115001L0 CRYSTAL 7.2MHz  
SU01 SP02011000 PUSH SWITCH POWER  
VR01 HQ30706060 DISPLAY UNIT FIP7Q8C  
XR01 FQ04003010 CERAMIC VIB CSB400P

## NOTE ON SAFETY :

Symbol  $\triangle$  Fire or electrical shock hazard. Only original parts should be used to replace any part marked with symbol  $\triangle$ . Any other component substitution (other than original type), may increase risk of fire or electrical shock hazard.

Components and wiring are subject to ch